



***Sounding Rockets, Balloons, and ELVs:
a look at Wallops Mission Graphics and
working for NASA***

Shannon Bull
September 20, 2018



Outline



- Overview of WFF and GSFC
- Current Mission Graphics System
- Range Data Display System (RDDS) goals
- Simulation and Display
- Common Display System
- Graphics for ASPIRE III launch
- The future of RDDS
- Opportunities at NASA



Wallops Flight Facility: Overview



- WFF is the only NASA owned and operated launch range
- Operated under Goddard Space Flight Center
- Flight assets:
 - Research Aircraft
 - Unmanned Aerial Systems
 - High-altitude Balloons
 - Suborbital rockets
 - Orbital rockets (ELVs)





Wallops Flight Facility: History



- Established 1945 under National Advisory Committee for Aeronautics (NACA)
- NASA established in 1958
- Explorer IX first launch from Wallops to successfully achieve orbit (1961)
- Lunar Atmosphere and Dust Environment Explorer (LADEE) launched 2013

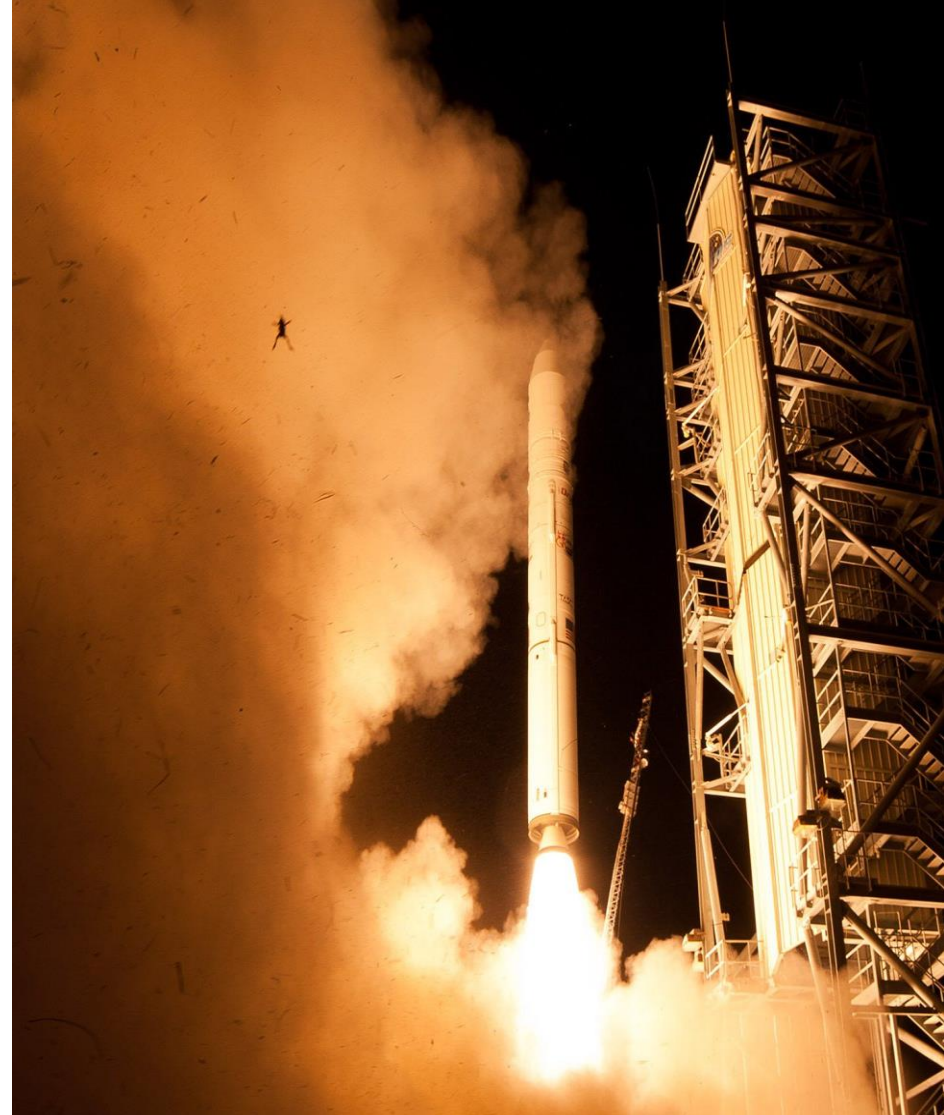



Wallops Flight Facility: Missions



- Sounding rockets (NSRP)
- Scientific Balloons
- Research Aircraft
- Range and Mission Management
- Near Earth Network

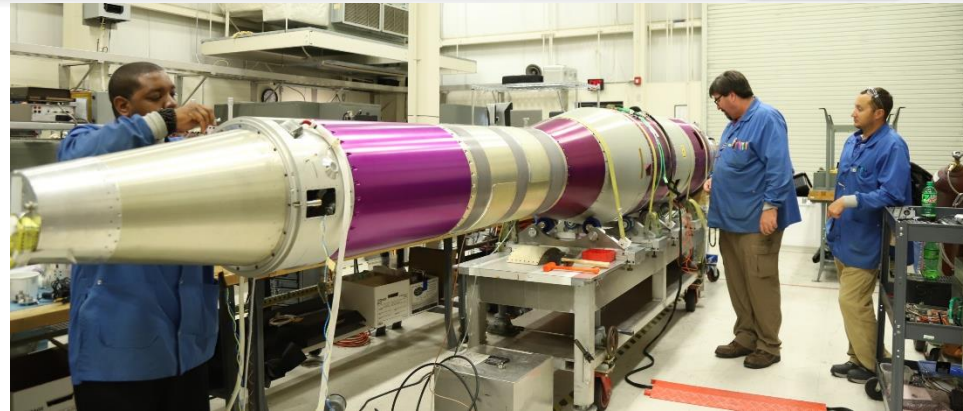

THE NEAR EARTH NETWORK PROJECT

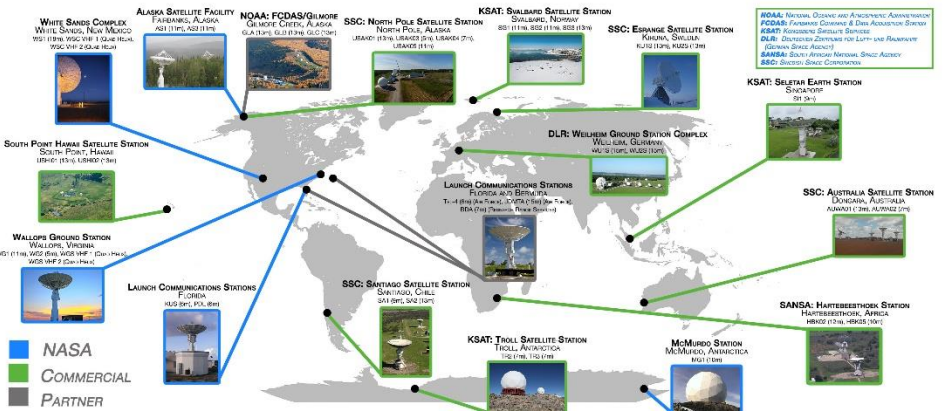



Goddard Space Flight Center Locations



Wallops Flight Facility (Wallops Island, VA)



Goddard Space Flight Center (Greenbelt, MD)



Goddard Institute for Space Studies (New York, NY)



Independent Verification and Validation (Fairmont, WV)



Organization of GSFC



Goddard Space Flight Center - Center Org Chart

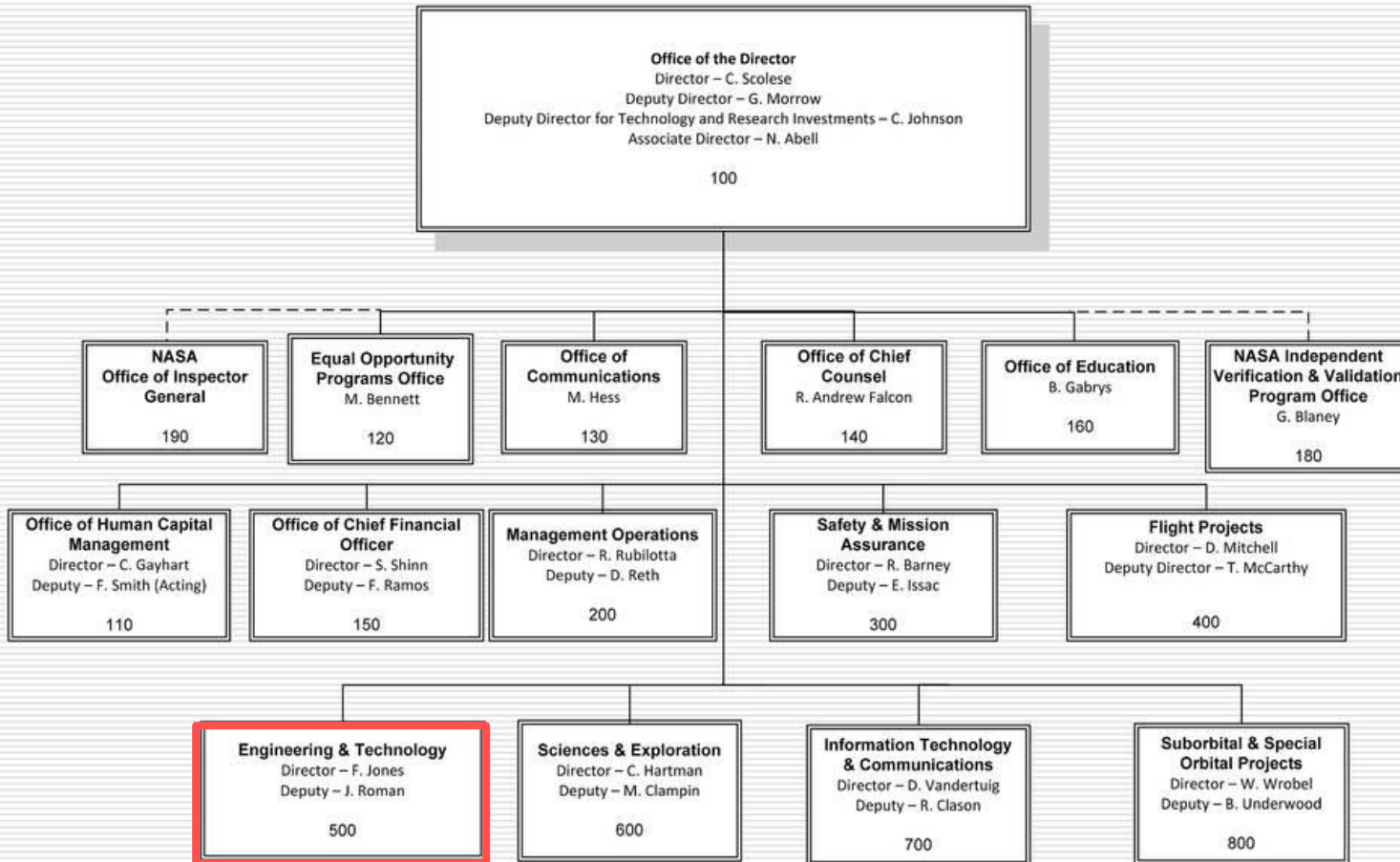



Engineering Technology Directorate



- Business Management: Code 501
- Mechanical Systems Division (540's)
- Instrument Systems and Technology Division (550's)
- Electrical Engineering Division (560's)
- Software Engineering Division (580's)
 - Wallops System Software Engineering Branch (589)
- Mission Engineering and System Analysis Division (590's)





Outline



- Overview of WFF and GSFC
- Current Mission Graphics System
- Range Data Display System (RDDS) goals
- Simulation and Display
- Common Display System
- Graphics for ASPIRE III launch
- The future of RDDS
- Opportunities at NASA



Current Mission Graphics System



- Primarily used by Range Safety Officers
- Provides visual representation of incoming radar and telemetry data
- Used to identify the location, health, and current status of rockets post launch





Current Mission Graphics System

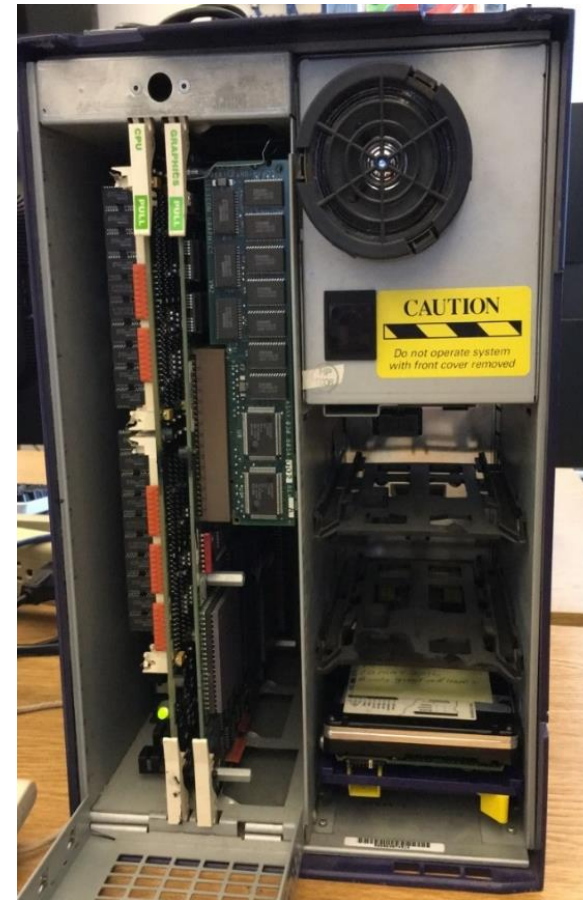



Current Mission Graphics System

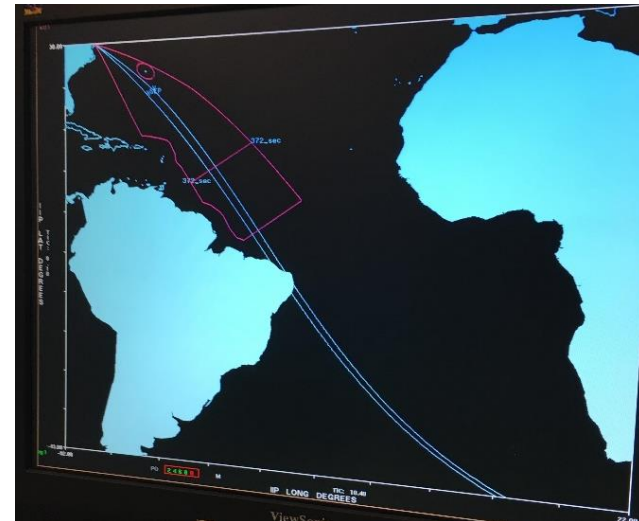
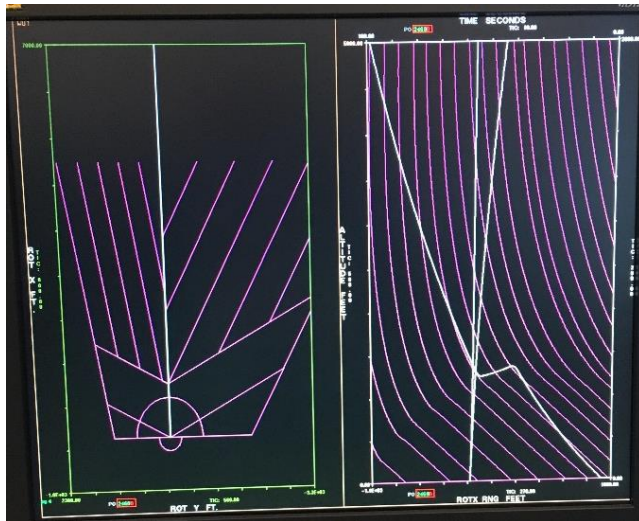
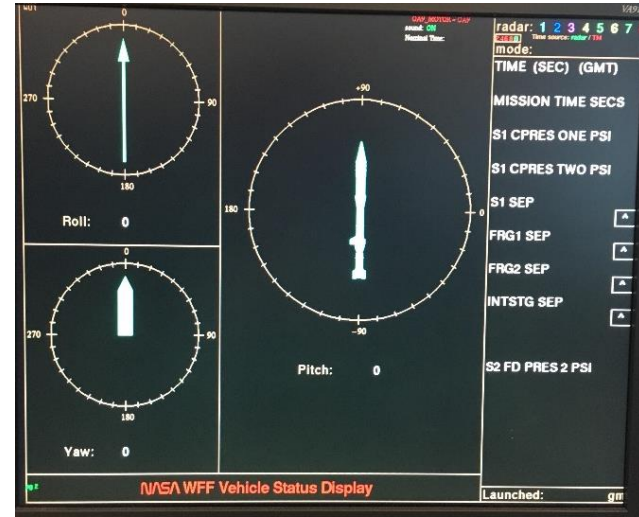



Outline



- Overview of WFF and GSFC
- Current Mission Graphics System
- Range Data Display System (RDDS) goals
- Simulation and Display
- Common Display System
- Graphics for ASPIRE III launch
- The future of RDDS
- Opportunities at NASA



Range Data Display System



- The Wallops Flight Facility Range and Mission Management Office (RMMO) is in need of a replacement for the current Mission Graphics systems in the Range Control Center (RCC).
 - Current system is over 20 years old
 - Hardware deemed obsolete
 - This project has been selected as the number two risk for the range
- The Range Data Display System (RDDS) will provide the Wallops Range with a **new and improved graphics system** to monitor mission status and **enhance situational awareness**.



Challenges of RDDS



- Deemed Class B: Safety Critical project
- Multiple systems must merge for one cohesive delivery
- Strict project timeline
- Must meet the needs and preferences of each RSO
- Graphics subsystem alone has over 80 Requirements

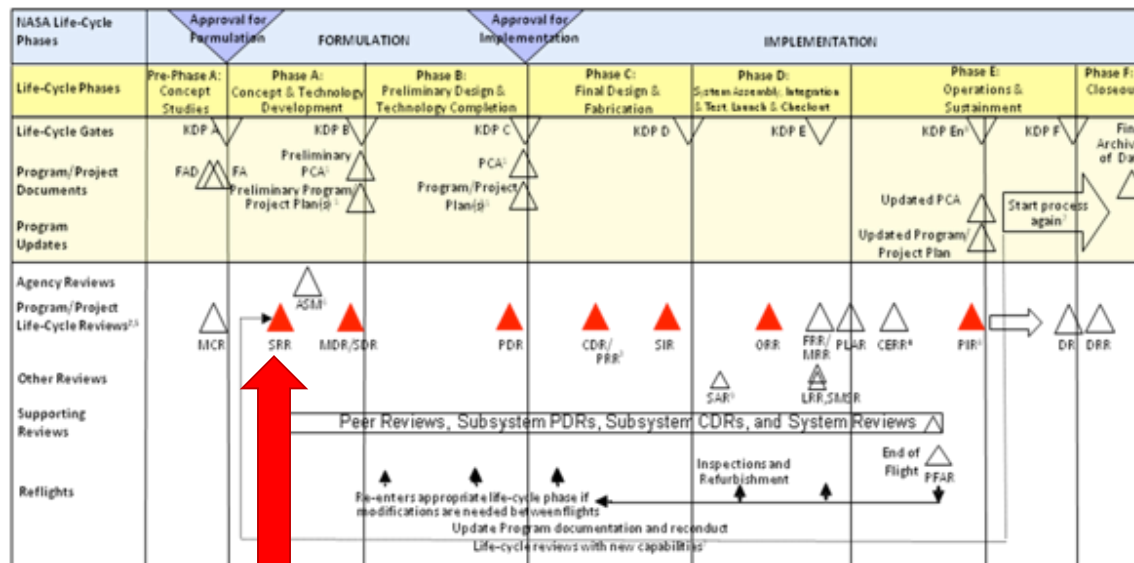



RDDS Preliminary Trade Studies



- “Determine how various Government off the Shelf (GOTS) products meet RDDS graphics requirements”
- Why GOTS?
 - Trusted
 - Inexpensive
 - Reliable



Outline



- Overview of WFF and GSFC
- Current Mission Graphics System
- Range Data Display System (RDDS) goals
- Simulation and Display
- Common Display System
- Graphics for ASPIRE III launch
- The future of RDDS
- Opportunities at NASA



Simulation and Display: SIMDIS



- Developed by Naval Research Lab
- Multiple DOD users for situational awareness
 - White sands missile range
 - Naval Undersea Warfare Center
 - Pacific Missile Range Facility
- Available for Windows and Linux OS
- Easily configurable
- Meets 17 mission graphics Requirements





SIMDIS

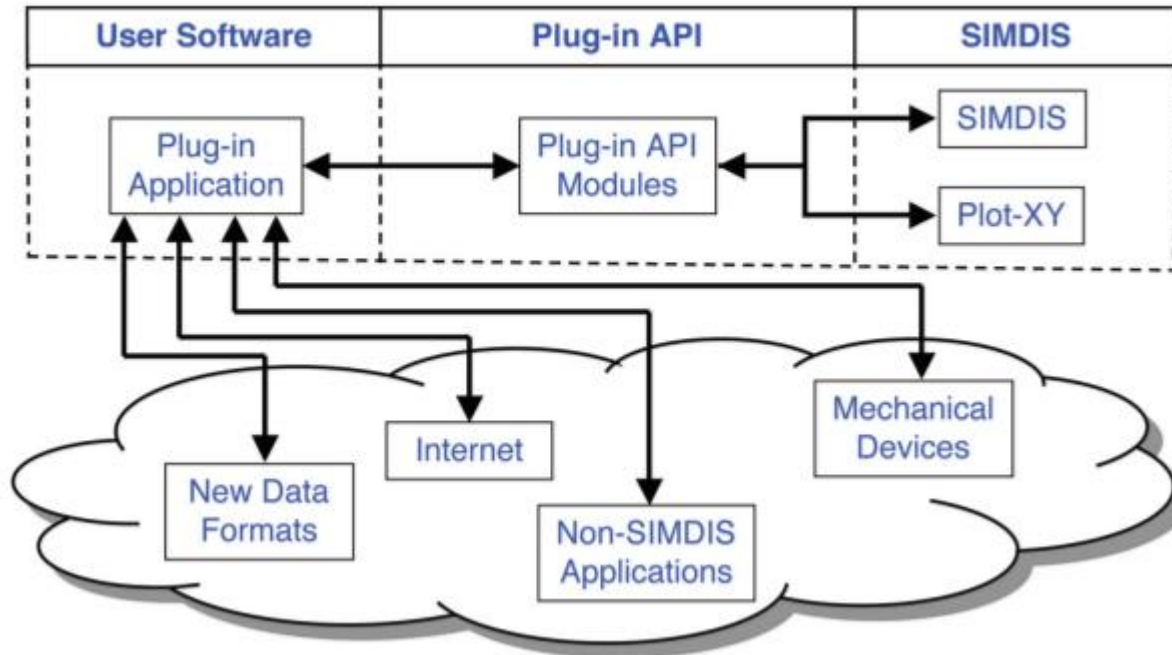

Integration of external data sources with SIMDIS through the plug-in API:



SIMDIS



- Qt UI to provide configuration of user's display
- Programs to generate scenarios, trajectories, and overlays in SIMDIS's preferred format
- New view files, overlays, and scenarios to model previous launches from WFF

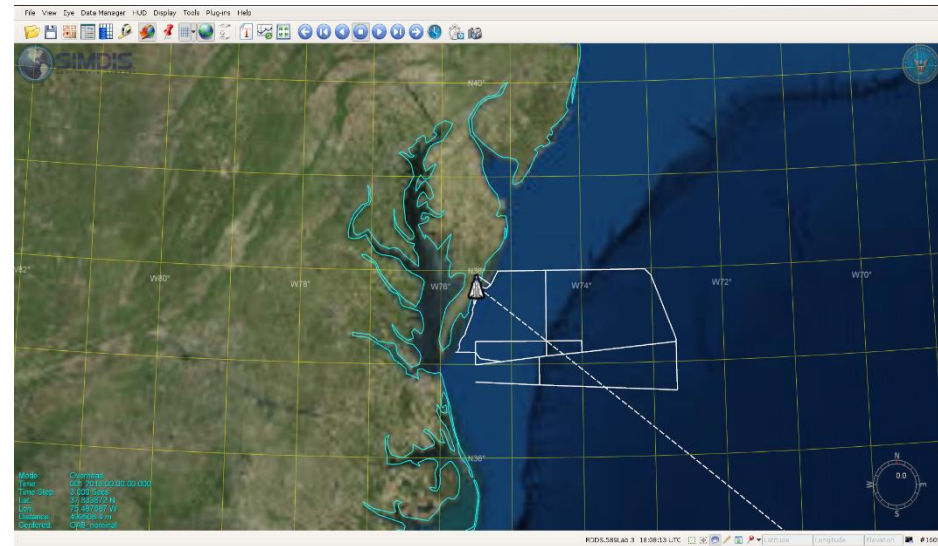



Outline



- Overview of WFF and GSFC
- Current Mission Graphics System
- Range Data Display System (RDDS) goals
- Simulation and Display
- Common Display System
- Graphics for ASPIRE III launch
- The future of RDDS
- Opportunities at NASA



Common Display System



- Developed by Naval Air Warfare Center
- Multiple DOD users for situational awareness
 - Surface Combat Systems Center
 - Reagan Test Range
 - Alaska Aerospace Complex
- Available for Windows OS
- Ability to record and playback data
- Meets 35 graphics requirements





Common Display System



Additional Pros:

- ✓ Configurable
- ✓ Many existing plugins to format data
- ✓ Extensive documentation and available SDK

Drawbacks:

- × Plugins are only supported using MS Visual Studio 2010
- × No common help desk



Outline



- Overview of WFF and GSFC
- Current Mission Graphics System
- Range Data Display System (RDDS) goals
- Simulation and Display
- Common Display System
- Graphics for ASPIRE III launch
- The future of RDDS
- Opportunities at NASA



ASPIRE III Sounding Rocket Launch



- Advanced Supersonic Parachute Inflation Research Experiment
- Parachute test for future MARS missions
- Low-density, supersonic environment
- Original Launch Date: July 31st
- Actual Launch Date: September 7th

JPL
Jet Propulsion Laboratory

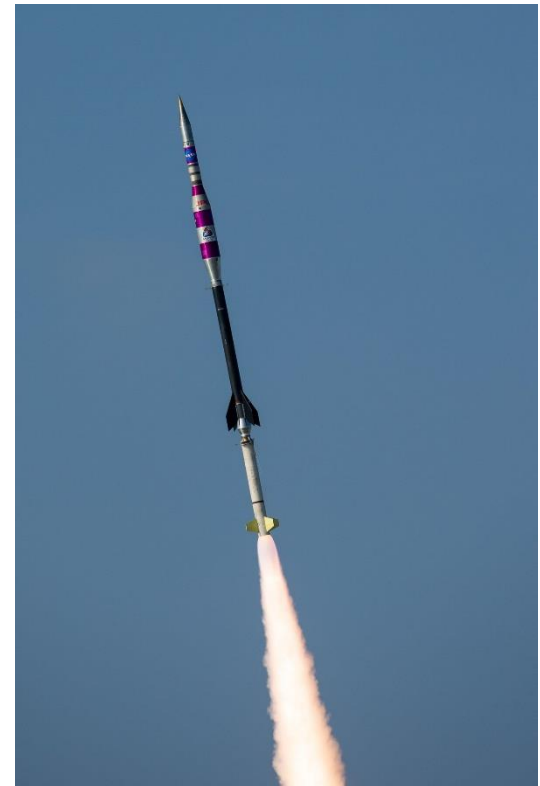



ASPIRE III Radar Data Flow

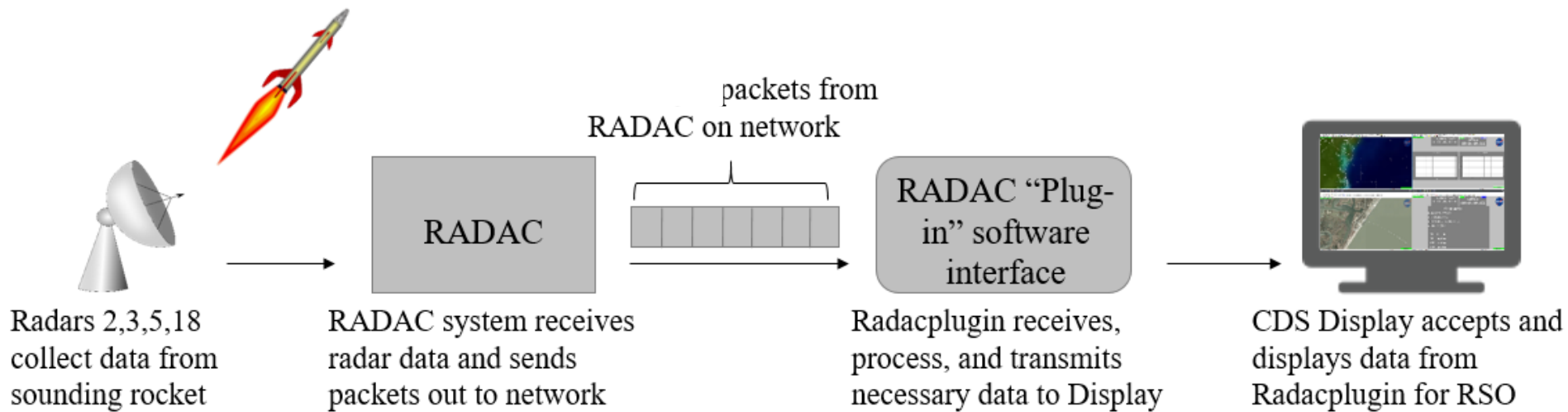



RADAC Plugin Interface



- Written using Microsoft Visual Studio 2010
- Utilize socket programming to receive packets of data from RADAC
- Determine the “best” radar source
- Parse up radar packets to pull out the measurements from the current “best”
- Interface with the CDS Display application to transmit data which will allow user to view measurements in real time



CDS configuration for ASPIRE III

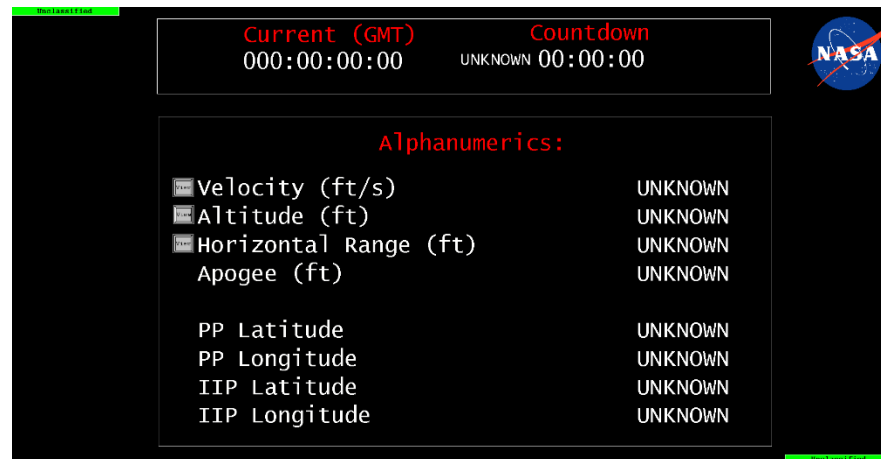
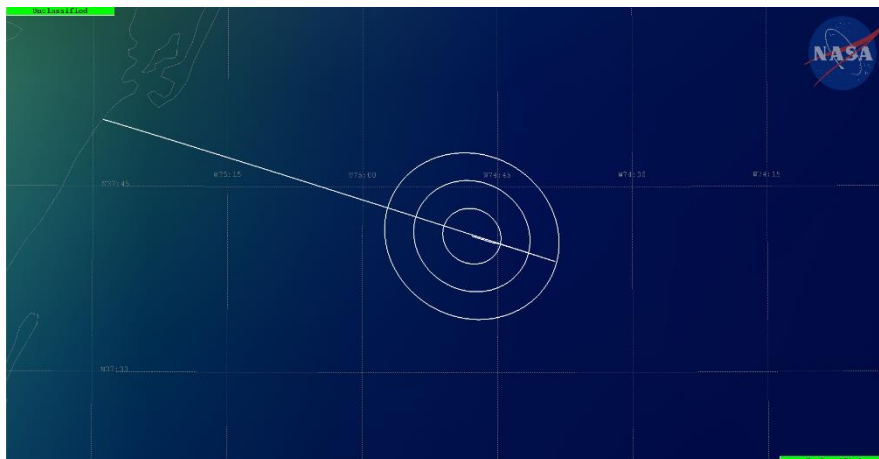
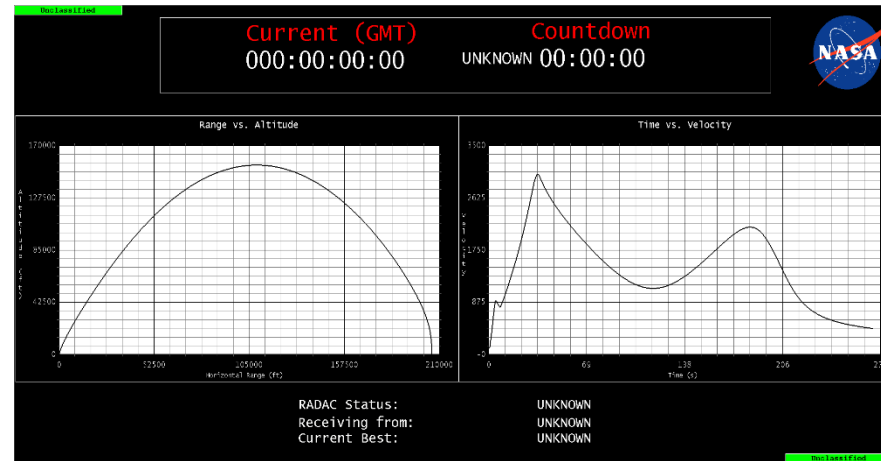
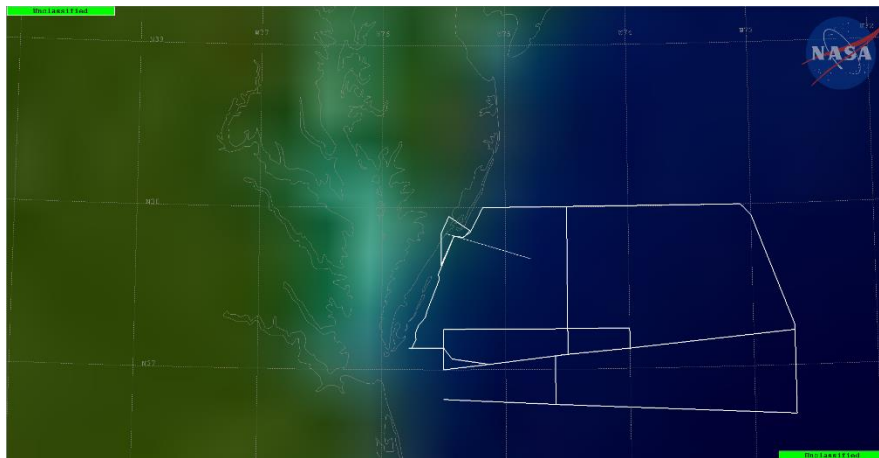



New Features



GIS Imagery provided
Surface Combat Systems
Center

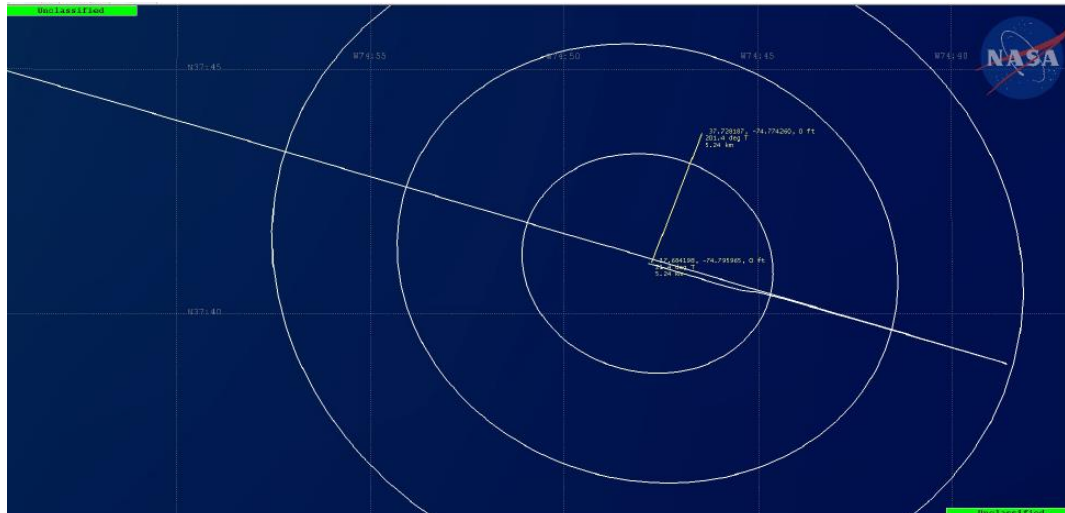

Ability to measure
geographic distances in
real time



New Features (cont'd)



- ✓ Improved RADAC status indicators
- ✓ Dynamic rotation and transition of trajectories, hazard zones, and other overlays
- ✓ Ability to plot multiple nominal trajectories at once
- ✓ Auto pan to keep target centered
- ✓ Increased user interface capabilities
- ✓ Additional displays to supplement alphanumeric text



Outline



- Overview of WFF and GSFC
- Current Mission Graphics System
- Range Data Display System (RDDS) goals
- Simulation and Display
- Common Display System
- Graphics for ASPIRE III launch
- The future of RDDS
- Opportunities at NASA



Future of RDDS



- Completed Software Requirements Review
- Begin official trade studies
- Configure CDS for the upcoming Antares launch
 - Better showcase of capabilities per RSO's needs
 - New plugins for each radar source
 - VTARS telemetry data being received
 - More displays necessary to display pertinent and safety critical data coming from radar and telemetry



Experiences



ROCKSAT sounding rocket launch in July



Experiences



Thunderbirds air show



Experiences



- Tours of island and range control center
- Safety training : Mission Success First & RSO orientation
- INSPIRE day
- Lunch and Learns to spread information on other projects and branches at WFF





Outline



- Overview of WFF and GSFC
- Current Mission Graphics System
- Range Data Display System (RDDS) goals
- Simulation and Display
- Common Display System
- Graphics for ASPIRE III launch
- The future of RDDS
- Opportunities at NASA



Other projects in code 589



- Boat and plane surveillance systems
- Range Data Acquisition Computer (RADAC)
- Web and mobile platform applications
 - “What’s up at Wallops”
 - Other internally used web and mobile apps
- Independent test team
- Mission Planning Lab





Why Wallops?



- Variety of other codes to cover different interests
 - Safety (803)
 - Electrical (569)
 - Mechanical (548)
 - IT (780)
- Witness live rocket launches
- Prime location
 - Under an hour from Salisbury's campus
 - Benefits of working on an island





Employment and Internship Opportunities



- NASA Pathways Co-op program
 - Undergraduate
 - Graduate
- Summer and semester Internships
- *Recent Graduate Hiring

USAJOBS[®]
"WORKING FOR AMERICA"

*All computer science majors need to meet AST requirements to work as a “Computer Engineer” for Goddard Space Flight Center.



Questions?



Special thanks to Jeff Dorman, RDDS project team, and the code 589 family



Contact me: sbull1@gulls.salisbury.edu